



SGM8140

Low Power, Vibration Sensor and PIR Sensor Analog Front End (AFE)

PRODUCT DESCRIPTION

The SGM8140 is a PIR sensor and vibration sensor analog front end which consists of 2 independent building block circuits. One is a dual rail-to-rail input and output operational amplifier, and the other is an ultra low power comparator. Both the operational amplifier and the comparator have been specifically designed to operate over a wide range of voltages from 1.4V to 5.5V. The SGM8140 only has 1.1 μ A working current, so it is ideal for use in a variety of battery-powered applications.

The operational amplifier circuit is guaranteed to operate with a single supply voltage as low as 1.4V. It has a gain-bandwidth product of 5kHz (TYP) and is unity gain stable. These specifications make this operational amplifier appropriate for low frequency applications, such as battery current monitoring and sensor conditioning.

Featuring a push-pull output stage, the SGM8140's comparator allows for operation with absolute minimum power consumption when driving any capacitive or resistive load.

The SGM8140 is specified for the -40°C to +85°C industrial temperature range. The SGM8140 is available in the Green TQFN-4x4-16L package.

FEATURES

- **Ultra Low Power: 1.1 μ A (TYP) at $V_S = 5V$**
- **Wide Supply Voltage Range: 1.4V to 5.5V**
- **Rail-to-Rail Input and Output Amplifier**
- **Amplifier Gain-Bandwidth Product: 5kHz (TYP) at $V_S = 5V$**
- **Amplifier is Unity Gain Stable**
- **Comparator Propagation Delay: 6 μ s (TYP)**
- **Comparator Push-Pull Output Current Drive: 19mA (TYP) at $V_S = 5V$**
- **-40°C to +85°C Operating Temperature Range**
- **Available in Green TQFN-4x4-16L Package**

APPLICATIONS

Toll Booth Tags
Wearable Products
Temperature Measurement
Battery Powered System
Vibration Detector
Alarm and Monitoring Circuits

PACKAGE/ORDERING INFORMATION

MODEL	PACKAGE DESCRIPTION	SPECIFIED TEMPERATURE RANGE	ORDERING NUMBER	PACKAGE MARKING	PACKING OPTION
SGM8140	TQFN-4×4-16L	-40°C to +85°C	SGM8140YTQE16G/TR	SGM8140 YTQE16 XXXXX	Tape and Reel, 3000

NOTE: XXXXX = Date Code and Vendor Code.

Green (RoHS & HSF): SG Micro Corp defines "Green" to mean Pb-Free (RoHS compatible) and free of halogen substances. If you have additional comments or questions, please contact your SGMICRO representative directly.

ABSOLUTE MAXIMUM RATINGS

Supply Voltage, V_{CC} 6V
 Input Common Mode Voltage Range
 $(-V_S) - 0.1V$ to $(+V_S) + 0.1V$
 Differential Input Voltage..... $|(-V_S) - (+V_S)|$
 Junction Temperature150°C
 Storage Temperature Range-65°C to +150°C
 Lead Temperature (Soldering, 10sec)260°C
 ESD Susceptibility
 HBM.....4000V
 CDM1000V

RECOMMENDED OPERATING CONDITIONS

Operating Temperature Range-40°C to +85°C

PIN CONFIGURATION

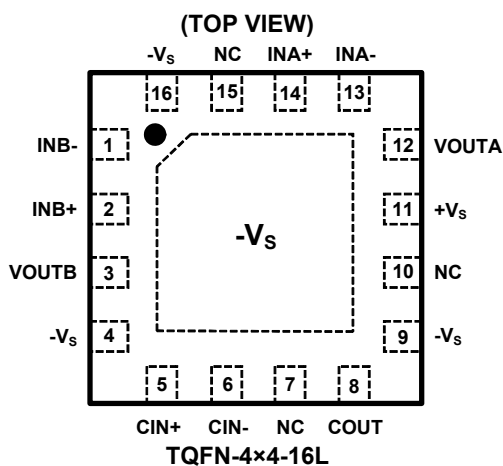

OVERSTRESS CAUTION

Stresses beyond those listed may cause permanent damage to the device. Functional operation of the device at these or any other conditions beyond those indicated in the operational section of the specification is not implied. Exposure to absolute maximum rating conditions for extended periods may affect reliability.

ESD SENSITIVITY CAUTION

This integrated circuit can be damaged by ESD if you don't pay attention to ESD protection. SGMICRO recommends that all integrated circuits be handled with appropriate precautions. Failure to observe proper handling and installation procedures can cause damage. ESD damage can range from subtle performance degradation to complete device failure. Precision integrated circuits may be more susceptible to damage because very small parametric changes could cause the device not to meet its published specifications.

DISCLAIMER

SG Micro Corp reserves the right to make any change in circuit design, specification or other related things if necessary without notice at any time.

BLOCK DIAGRAM

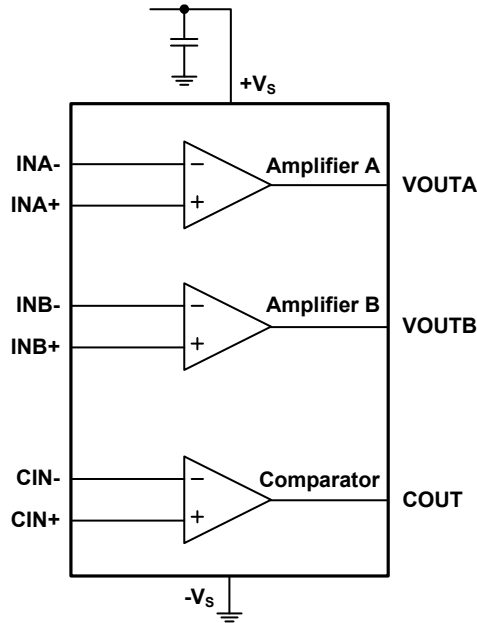

PIN DESCRIPTION

PIN	NAME	FUNCTION
1	INB-	Negative Input of Amplifier B.
2	INB+	Positive Input of Amplifier B.
3	VOUTB	Output of Amplifier B.
4	-Vs	Negative Supply. Always connect this pin to ground for single power supply Application.
5	CIN+	Positive Input of Comparator.
6	CIN-	Negative Input of Comparator.
7	NC	No Connection.
8	COUT	Output of Comparator.
9	-Vs	Negative Supply. Always connect this pin to ground for single power supply Application.
10	NC	No Connection.
11	+Vs	Positive Power Supply.
12	VOUTA	Output of Amplifier A.
13	INA-	Negative Input of Amplifier A.
14	INA+	Positive Input of Amplifier A.
15	NC	No Connection.
16	-Vs	Negative Supply. Always connect this pin to ground for single power supply Application.

ELECTRICAL CHARACTERISTICS

PARAMETER	CONDITIONS	MIN	TYP	MAX	UNITS
Quiescent Current	$V_S = 5V, V_{CM} = 2.5V, T_A = +25^\circ C$		1.1	2.2	μA
	$V_S = 1.4V, V_{CM} = 0.7V, T_A = +25^\circ C$		0.9		

Operational Amplifier Only

($V_S = 1.4V$ to $5V, -V_S = GND, T_A = +25^\circ C, V_{CM} = V_S/2, V_{OUT} \approx V_S/2$ and $R_L = 1M\Omega$ to $V_S/2$, unless otherwise noted.)

PARAMETER	CONDITIONS	MIN	TYP	MAX	UNITS	
DC ELECTRICAL CHARACTERISTICS						
Input Offset Voltage (V_{OS})	$V_{CM} = V_S/2$		0.4	2.5	mV	
Input Offset Voltage Drift ($\Delta V_{OS}/\Delta T$)	$V_{CM} = V_S/2$		2		$\mu V/^\circ C$	
Power Supply Rejection Ratio (PSRR)	$V_S = 1.4V$ to $5.5V$	69	80		dB	
Input Common Mode Voltage Range (V_{CMR})		$(-V_S) - 0.1$		$(+V_S) + 0.1$	V	
Common Mode Rejection Ratio (CMRR)	$V_S = 5V, V_{CM} = -0.1V$ to $5.1V$	68	83		dB	
	$V_S = 5V, V_{CM} = 2.5V$ to $5.1V$	67	82			
	$V_S = 5V, V_{CM} = -0.1V$ to $2.5V$	62	77			
Large Signal Voltage Gain (A_{VO})	$V_S = 1.4V, R_L = 50k\Omega, V_{OUT} = +V_S - 0.1V$	75	80		dB	
	$V_S = 5V, R_L = 50k\Omega, V_{OUT} = +V_S - 0.1V$	87	93			
Input Bias Current (I_B)			1		pA	
Input Offset Current (I_{OS})			1		pA	
Maximum Output Voltage Swing	V_{OH}	$V_S = 1.4V, R_L = 50k\Omega$		5	12	mV
		$V_S = 5V, R_L = 50k\Omega$		4	12	
	V_{OL}	$V_S = 1.4V, R_L = 50k\Omega$		4.6	12	mV
		$V_S = 5V, R_L = 50k\Omega$		3.6	12	
Short Circuit Current (I_{SC})	$V_S = 5V, \text{source}$	20	24		mA	
	$V_S = 5V, \text{sink}$	20	24			
Supply Voltage		1.4		5.5	V	
AC ELECTRICAL CHARACTERISTICS ($C_L = 60pF$)						
Gain-Bandwidth Product (GBP)	$V_S = 1.4V$		4.3		kHz	
	$V_S = 5V$		5			
Slew Rate (SR)	$V_S = 1.4V, V_{OUT} = 1V$ Step		1.3		V/ms	
	$V_S = 5V, V_{OUT} = 2V$ Step		1.6			
Phase Margin (PM)	$V_S = 1.4V$ to $5.5V$		60		$^\circ$	
Input Voltage Noise (e_n p-p)	$V_S = 1.4V, f = 0.1Hz$ to $10Hz$		4.4		μV_{P-P}	
	$V_S = 5V, f = 0.1Hz$ to $10Hz$		4.0			
Input Voltage Noise Density (e_n)	$V_S = 1.4V, f = 1kHz$		135		nV/\sqrt{Hz}	
	$V_S = 5V, f = 1kHz$		130			

ELECTRICAL CHARACTERISTICS

Comparator Only

(T_A = +25°C, V_S = 1.4V, -V_S = 0V, V_{CM} = V_S/2 and V_O = -V_S, unless otherwise noted.)

PARAMETER	SYMBOL	CONDITIONS	MIN	TYP	MAX	UNITS
Input Offset Voltage	V _{OS}	V _{CM} = 0V		0.5	3.3	mV
		V _{CM} = 1.4V		0.5	3.2	
Input Offset Average Drift				2		μV/°C
Common Mode Rejection Ratio	CMRR	V _{CM} Stepped from 0V to 0.3V		65		dB
		V _{CM} Stepped from 0.8V to 1.4V		75		
		V _{CM} Stepped from 0V to 1.4V		75		
Power Supply Rejection Ratio	PSRR	V _S = 1.8V to 5.5V, V _{CM} = 0V	65	95		dB
Large Signal Voltage Gain	A _{VO}			100		dB
Output Swing High	V _{OH}	V _S = 1.8V, I _O = 500μA		131	202	mV
		-40°C ≤ T _A ≤ +85°C			219	
		V _S = 1.8V, I _O = 1mA		292	476	
		-40°C ≤ T _A ≤ +85°C			512	
Output Swing Low	V _{OL}	V _S = 1.8V, I _O = -500μA		82	112	mV
		-40°C ≤ T _A ≤ +85°C			127	
		V _S = 1.8V, I _O = -1mA		167	225	
		-40°C ≤ T _A ≤ +85°C			253	
Output Current	I _{OUT}	Source		0.7		mA
		Sink		2.0		
Propagation Delay (High to Low)		Overdrive = 10mV		12		μs
		Overdrive = 100mV		6		
Propagation Delay (Low to High)		Overdrive = 10mV		26		μs
		Overdrive = 100mV		17		
Rise Time	t _{Rise}	Overdrive = 10mV, C _L = 30pF, R _L = 1MΩ		220		ns
		Overdrive = 100mV, C _L = 30pF, R _L = 1MΩ		220		
Fall Time	t _{Fall}	Overdrive = 10mV, C _L = 30pF, R _L = 1MΩ		155		ns
		Overdrive = 100mV, C _L = 30pF, R _L = 1MΩ		155		

ELECTRICAL CHARACTERISTICS

Comparator Only

($T_A = +25^\circ\text{C}$, $V_S = 5\text{V}$, $-V_S = 0\text{V}$, $V_{CM} = V_S/2$ and $V_O = -V_S$, unless otherwise noted.)

PARAMETER	SYMBOL	CONDITIONS	MIN	TYP	MAX	UNITS
Input Offset Voltage	V_{OS}	$V_{CM} = 0\text{V}$		0.5	3.3	mV
		$V_{CM} = 5\text{V}$		0.5	3.2	
Input Offset Average Drift				2		$\mu\text{V}/^\circ\text{C}$
Common Mode Rejection Ratio	CMRR	V_{CM} Stepped from 0V to 3.9V		85		dB
		V_{CM} Stepped from 4.4V to 5V		85		
		V_{CM} Stepped from 0V to 5V		85		
Power Supply Rejection Ratio	PSRR	$V_S = 1.8\text{V}$ to 5.5V , $V_{CM} = 0\text{V}$	65	95		dB
Large Signal Voltage Gain	A_{VO}			105		dB
Output Swing High	V_{OH}	$I_O = 500\mu\text{A}$		48	77	mV
		$-40^\circ\text{C} \leq T_A \leq +85^\circ\text{C}$			84	
		$I_O = 1\text{mA}$		96	136	
		$-40^\circ\text{C} \leq T_A \leq +85^\circ\text{C}$			152	
Output Swing Low	V_{OL}	$I_O = -500\mu\text{A}$		52	80	mV
		$-40^\circ\text{C} \leq T_A \leq +85^\circ\text{C}$			90	
		$I_O = -1\text{mA}$		104	130	
		$-40^\circ\text{C} \leq T_A \leq +85^\circ\text{C}$			143	
Output Current	I_{OUT}	Source	13.5	18		mA
		$-40^\circ\text{C} \leq T_A \leq +85^\circ\text{C}$	11.5			
		Sink	15	19		
		$-40^\circ\text{C} \leq T_A \leq +85^\circ\text{C}$	12.9			
Propagation Delay (High to Low)		Overdrive = 10mV		13		μs
		Overdrive = 100mV		6		
Propagation Delay (Low to High)		Overdrive = 10mV		42		μs
		Overdrive = 100mV		33		
Rise Time	t_{Rise}	Overdrive = 10mV, $C_L = 30\text{pF}$, $R_L = 1\text{M}\Omega$		85		ns
		Overdrive = 100mV, $C_L = 30\text{pF}$, $R_L = 1\text{M}\Omega$		85		
Fall Time	t_{Fall}	Overdrive = 10mV, $C_L = 30\text{pF}$, $R_L = 1\text{M}\Omega$		70		ns
		Overdrive = 100mV, $C_L = 30\text{pF}$, $R_L = 1\text{M}\Omega$		60		

TYPICAL PERFORMANCE CHARACTERISTICS

Operational Amplifier Only

$T_A = +25^\circ\text{C}$, $V_S = +1.4\text{V}$ to $+5\text{V}$, $-V_S = \text{GND}$, $V_{CM} = V_S/2$, $V_{OUT} \approx V_S/2$ and $R_L = 1\text{M}\Omega$ to $V_S/2$, $C_L = 60\text{pF}$, unless otherwise noted.

Large Signal Inverting Pulse Response

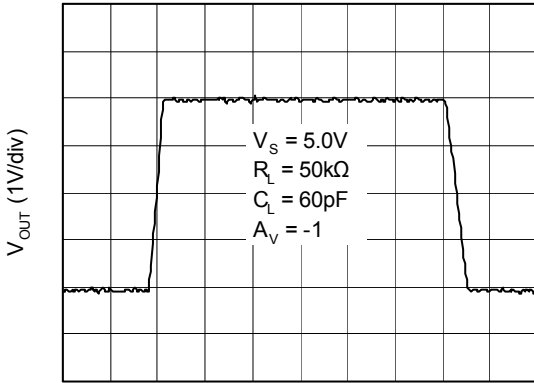

Time (5ms/div)

Large Signal Non-Inverting Pulse Response

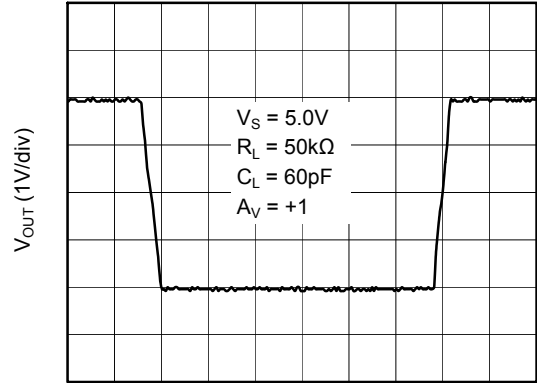

Time (5ms/div)

Small Signal Inverting Pulse Response

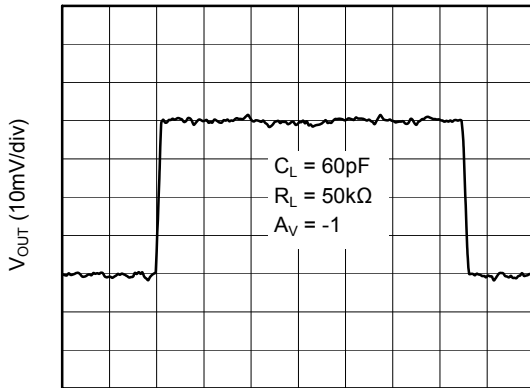

Time (5ms/div)

Small Signal Non-Inverting Pulse Response

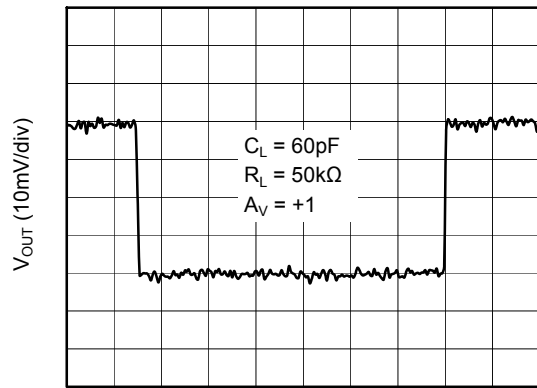

Time (5ms/div)

No Phase Reversal

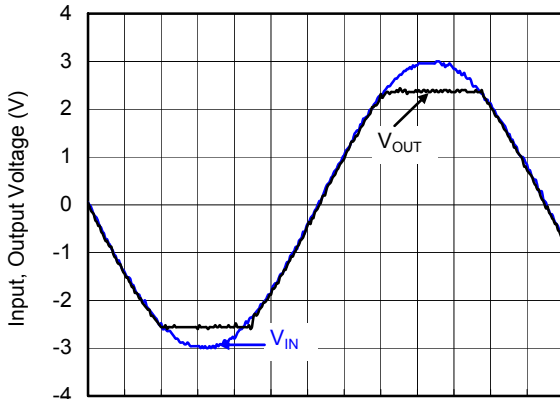

Time (5ms/div)

Slew Rate vs. Temperature

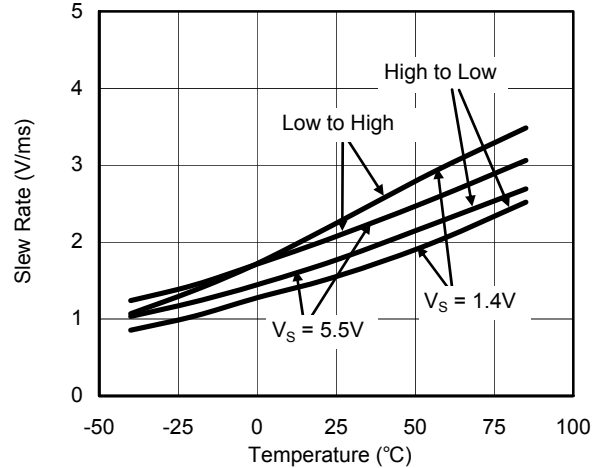

TYPICAL PERFORMANCE CHARACTERISTICS

Operational Amplifier Only

$T_A = +25^\circ\text{C}$, $V_S = +1.4\text{V}$ to $+5\text{V}$, $-V_S = \text{GND}$, $V_{CM} = V_S/2$, $V_{OUT} \approx V_S/2$ and $R_L = 1\text{M}\Omega$ to $V_S/2$, $C_L = 60\text{pF}$, unless otherwise noted.

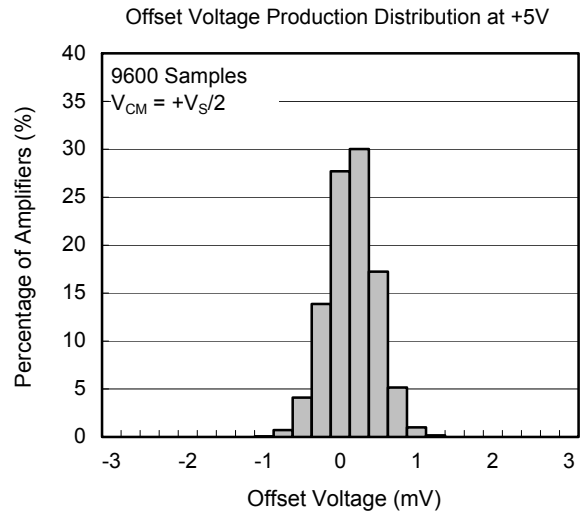
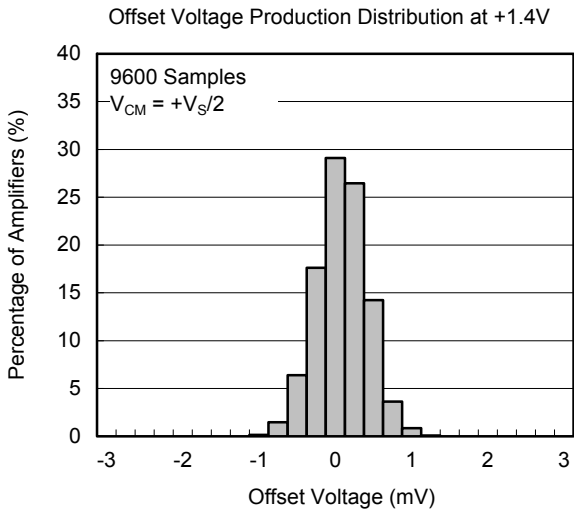

Comparator Only

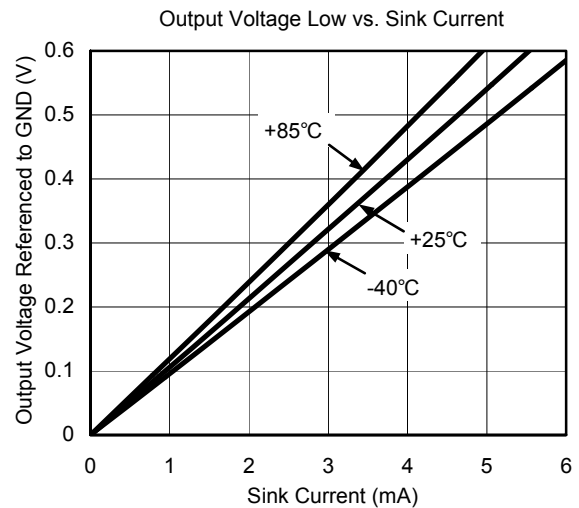
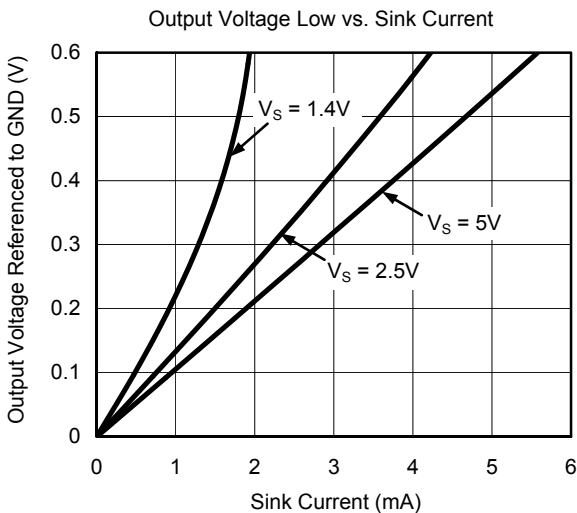

TYPICAL PERFORMANCE CHARACTERISTICS

Comparator Only

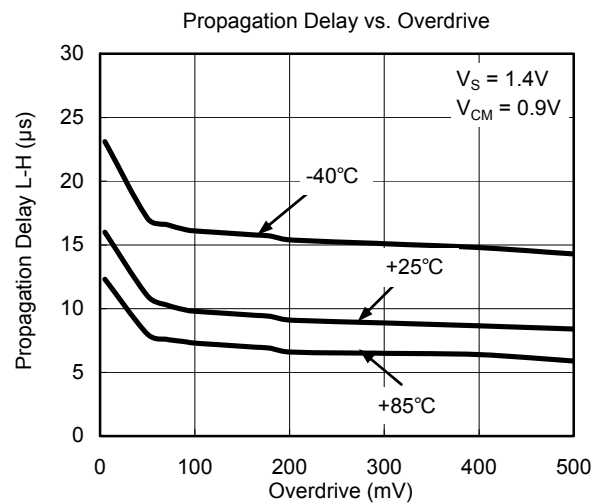
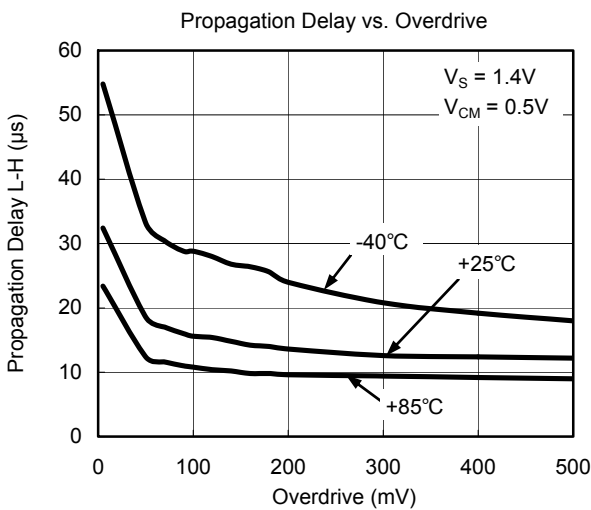
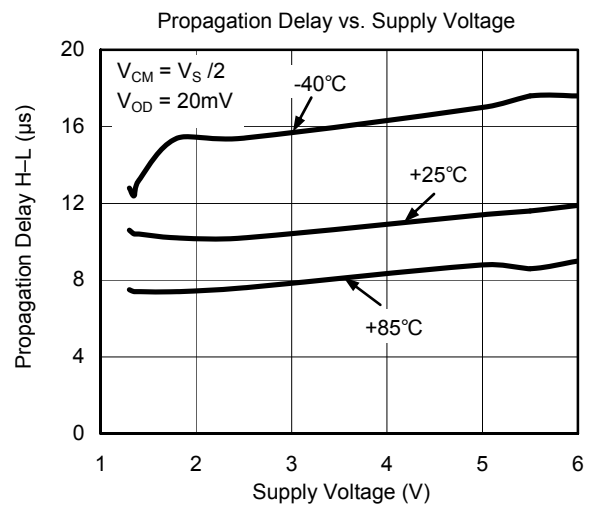
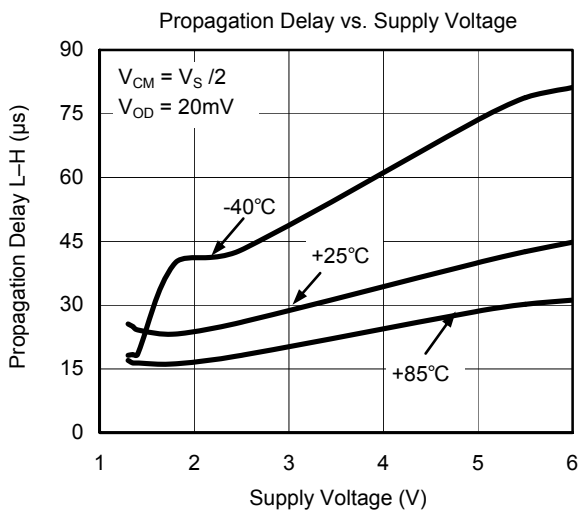
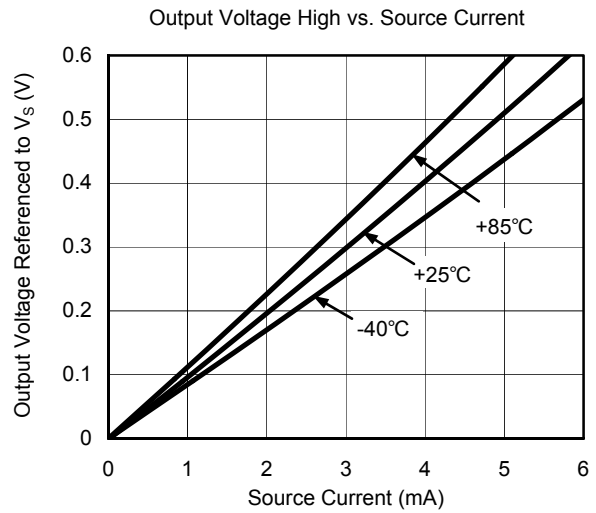
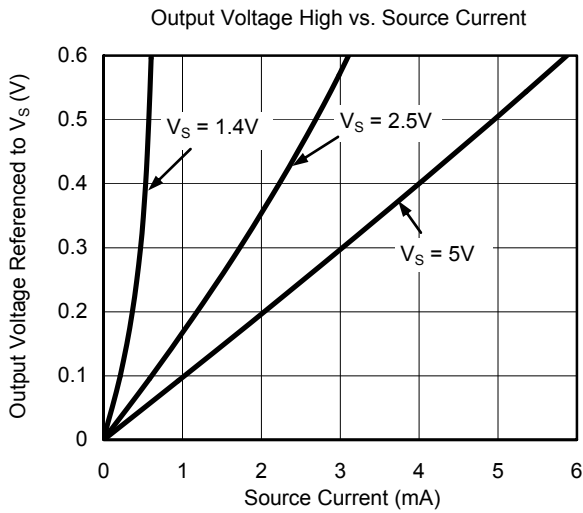

TYPICAL PERFORMANCE CHARACTERISTICS

Comparator Only

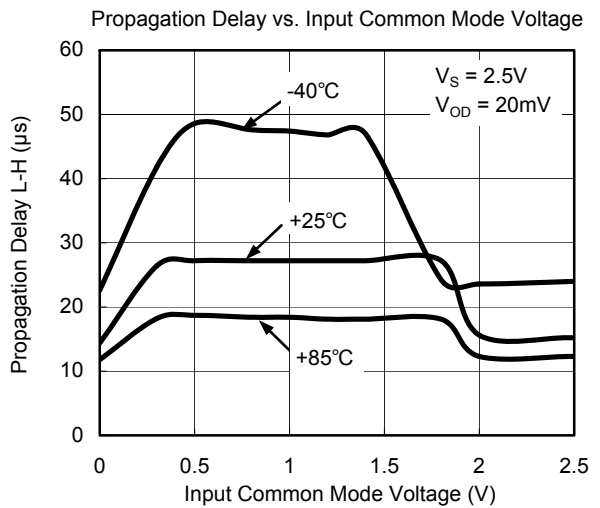
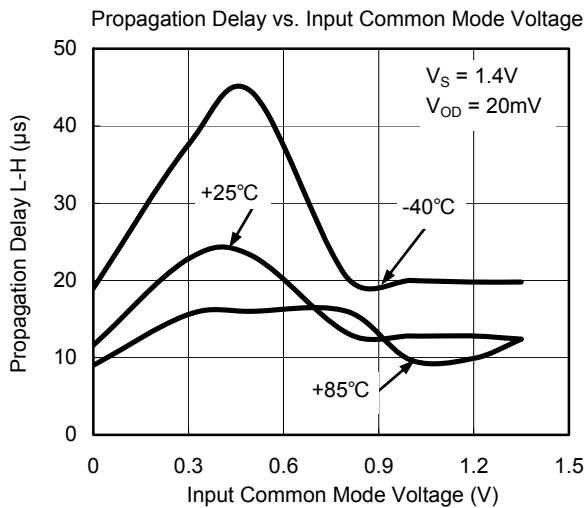
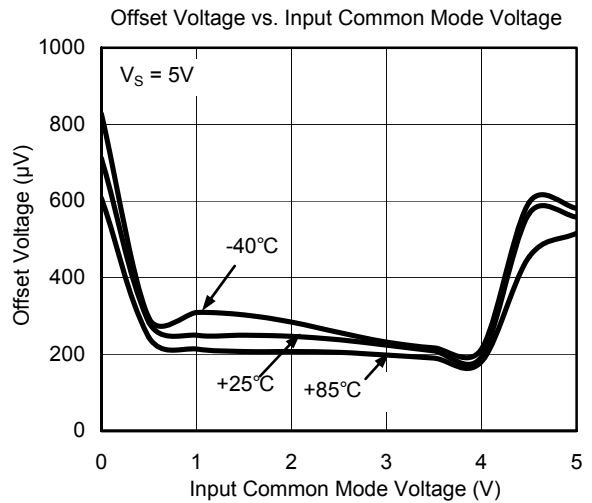
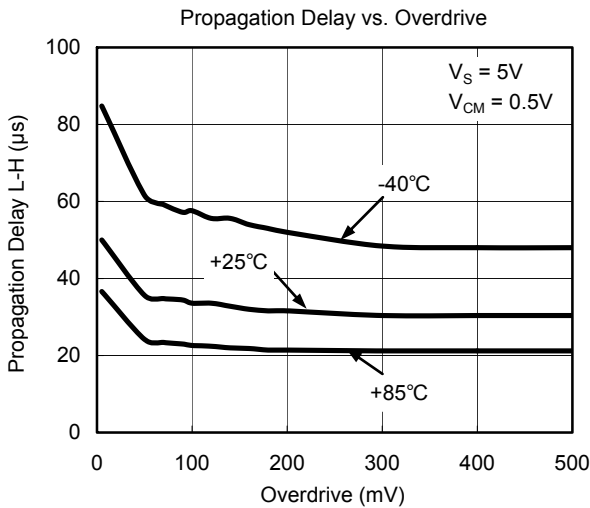
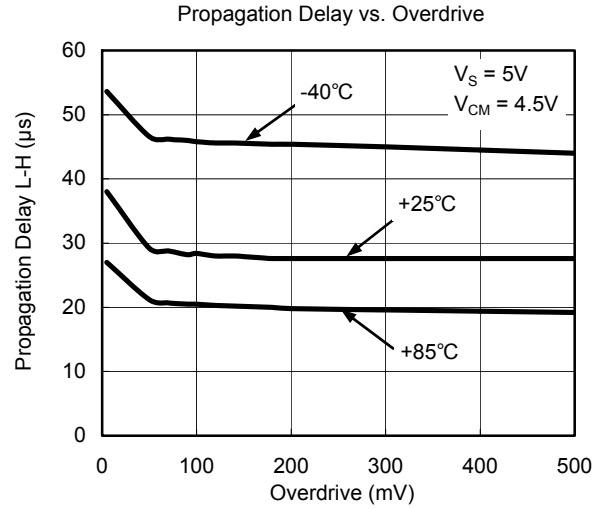
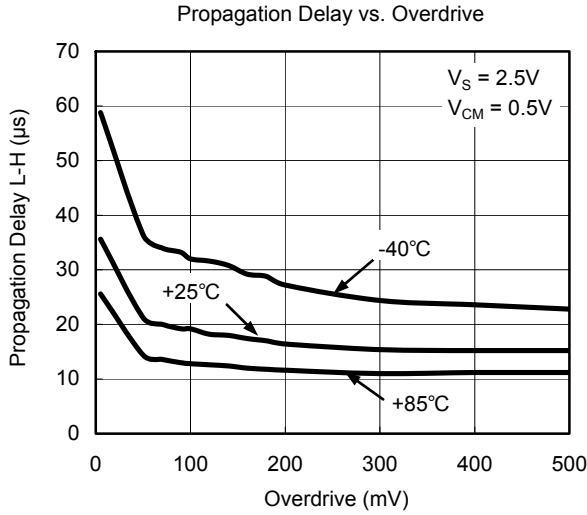

TYPICAL PERFORMANCE CHARACTERISTICS

Comparator Only

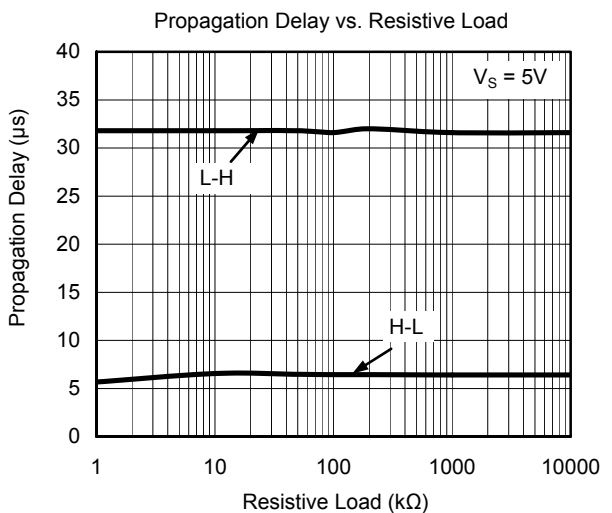
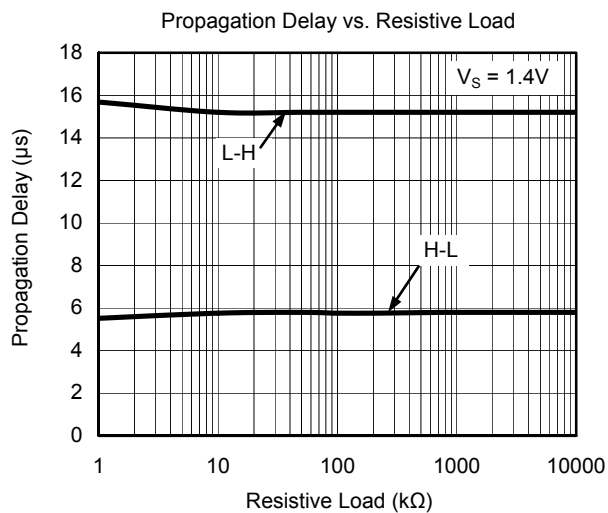
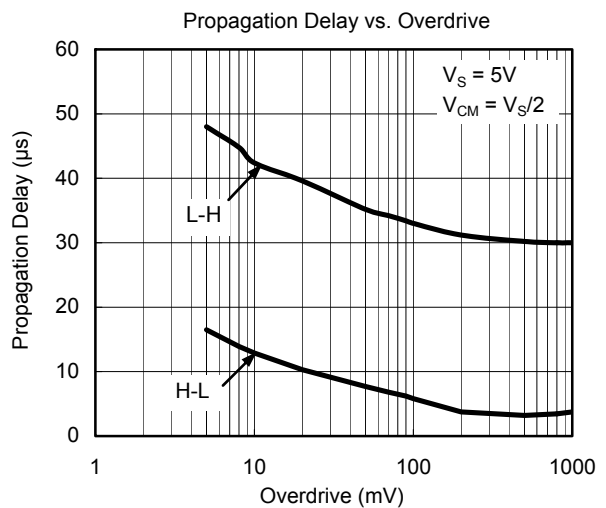
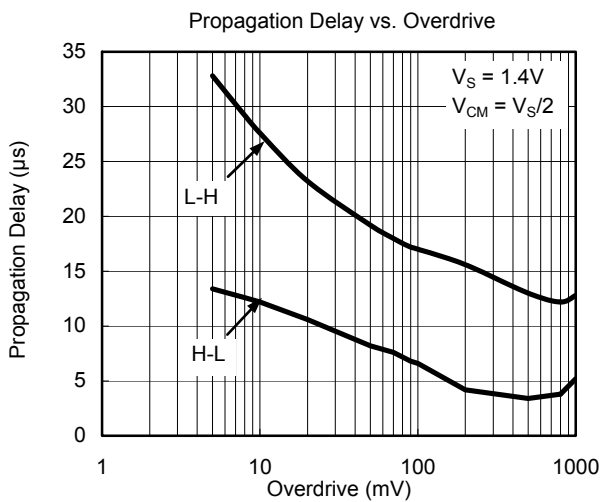
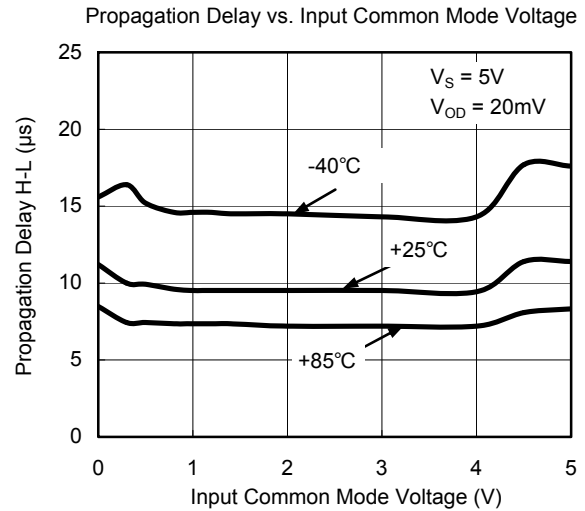
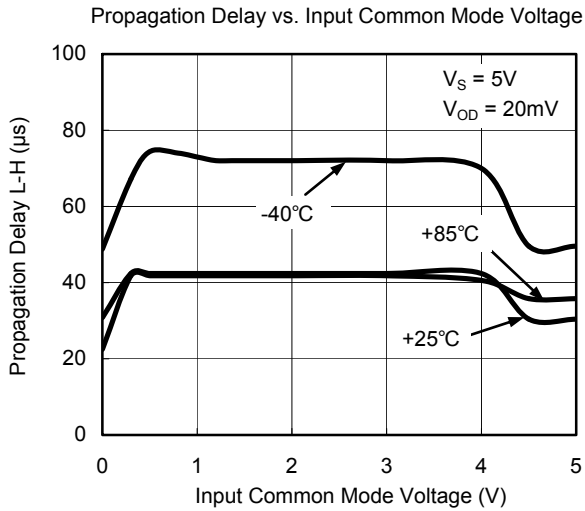

APPLICATION CIRCUIT

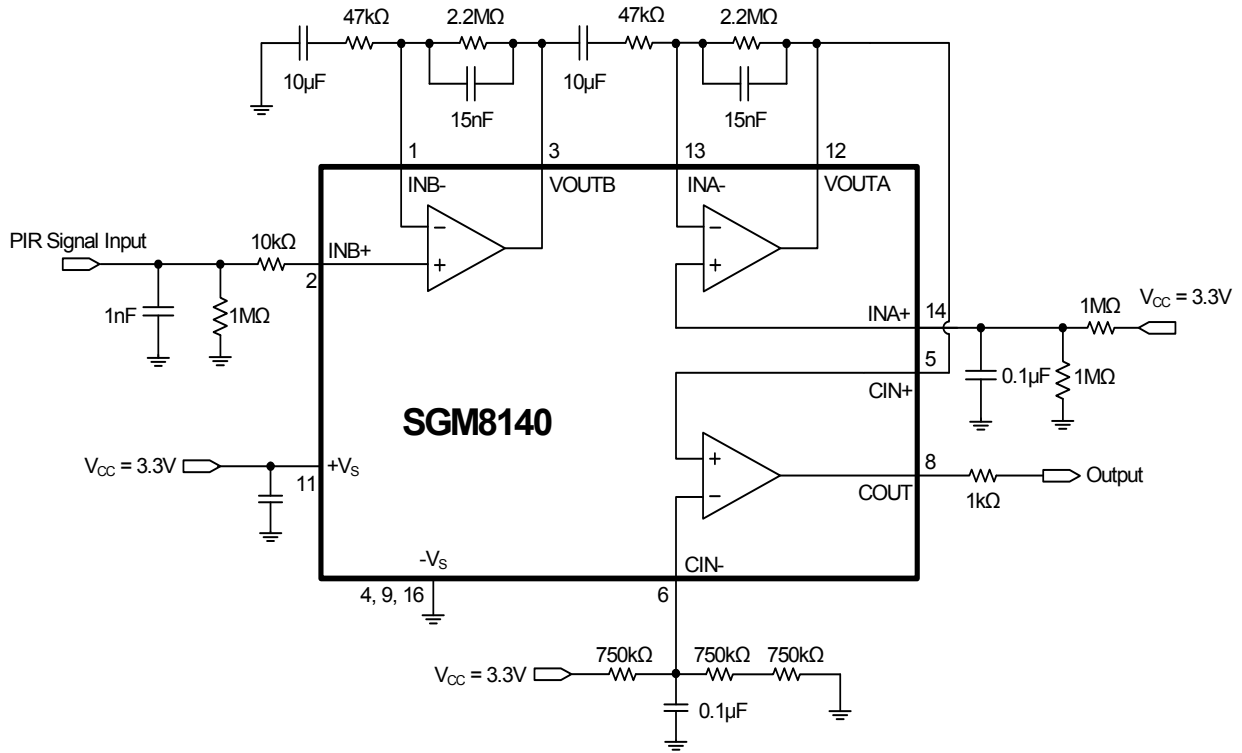
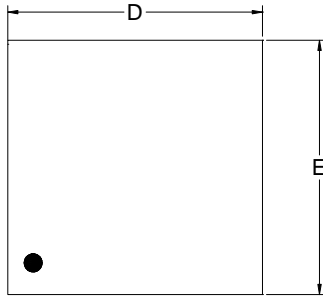

Figure 1. Application Circuit for PIR Sensor

PACKAGE OUTLINE DIMENSIONS

TQFN-4x4-16L



TOP VIEW

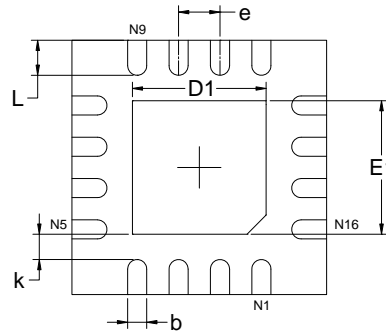

BOTTOM VIEW

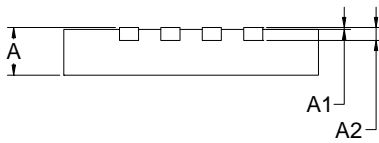

SIDE VIEW

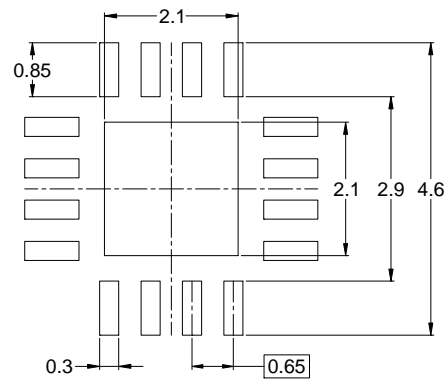

RECOMMENDED LAND PATTERN (Unit: mm)

Symbol	Dimensions In Millimeters		Dimensions In Inches	
	MIN	MAX	MIN	MAX
A	0.700	0.800	0.028	0.031
A1	0.000	0.050	0.000	0.002
A2	0.203 REF		0.008 REF	
D	3.900	4.100	0.154	0.161
D1	2.000	2.200	0.079	0.087
E	3.900	4.100	0.154	0.161
E1	2.000	2.200	0.079	0.087
k	0.200 MIN		0.008 MIN	
b	0.250	0.350	0.010	0.014
e	0.650 TYP		0.026 TYP	
L	0.450	0.650	0.018	0.026

TAPE AND REEL INFORMATION

REEL DIMENSIONS

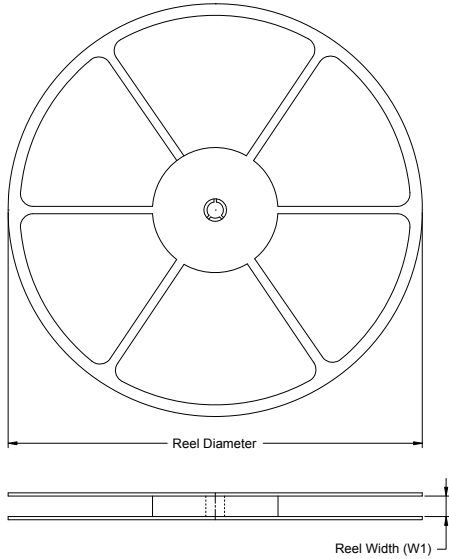

TAPE DIMENSIONS

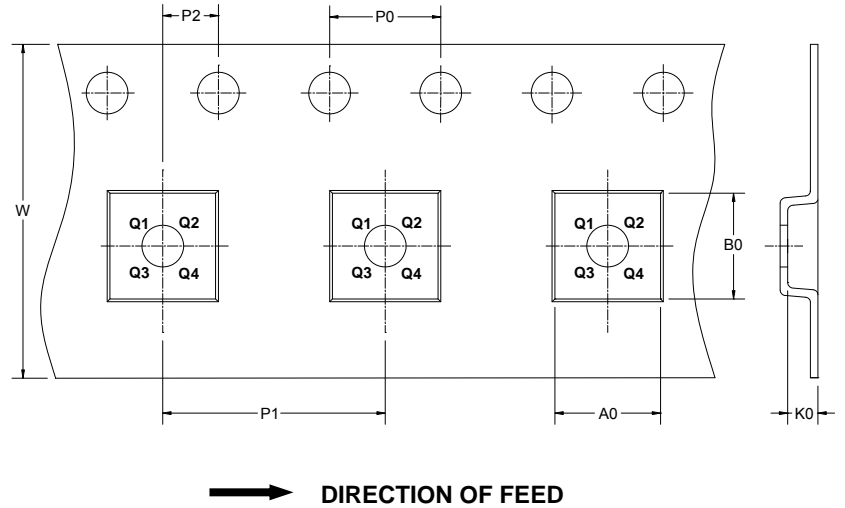

NOTE: The picture is only for reference. Please make the object as the standard.

KEY PARAMETER LIST OF TAPE AND REEL

Package Type	Reel Diameter	Reel Width W1 (mm)	A0 (mm)	B0 (mm)	K0 (mm)	P0 (mm)	P1 (mm)	P2 (mm)	W (mm)	Pin1 Quadrant
TQFN-4x4-16L	13"	12.4	4.3	4.3	1.1	4.0	8.0	2.0	12.0	Q1

DD0001

CARTON BOX DIMENSIONS

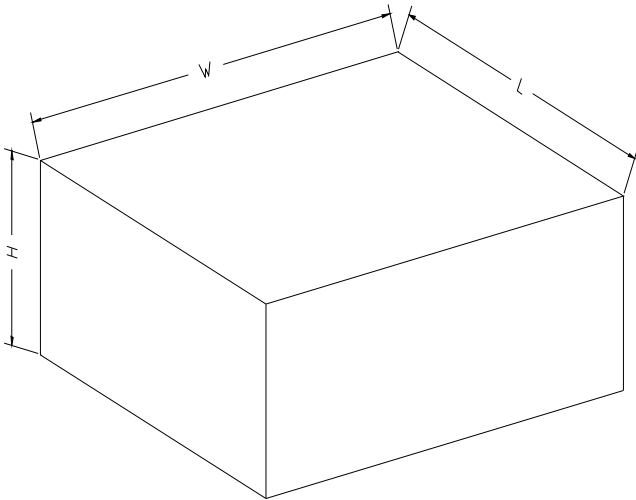

NOTE: The picture is only for reference. Please make the object as the standard.

KEY PARAMETER LIST OF CARTON BOX

Reel Type	Length (mm)	Width (mm)	Height (mm)	Pizza/Carton
13"	386	280	370	5

DP0002